

Precautions

Please read this instruction carefully before use.

- Do not attempt to disassemble or modify the product
- Keep the product away from the external shocks or vibrations.
- Do not use the damaged or peeled cables.
- Do not use the product outdoors.
- Product specifications and features are subject to change without notice.

Warranty Information

- Free warranty service
 - In case of the defect is found caused by the design or the production flaw while using the product properly, a manufacturer is responsible for the faulty product and the free warranty service for 1 year from the date of purchasing.
 - Even in the warranty service period, malfunction or damage of products caused by the inevitable incident such as a natural disaster is not subject of the free warranty service.
- Warranty service at a cost
 - The product that free warranty service period is expired.
 - Malfunction of the product caused by a user's fault.
 - Malfunction of the product caused by incidents.
 - Malfunction of the product caused by a natural disaster such as earthquake, flood, lightning and etc.
 - In case of the warranty service at a cost, a customer should cover the transportation costs.
- Examples of a user's fault
 - Fault in case of attempts to disassemble or modify the sCLK-EX.
 - Fault in case of not following the operating instructions correctly.
- Please read this operating instruction and FAQ section on our website carefully before asking for the warranty service.

Supplied contents

- A sCLK-EX : The name is changed according to the option and frequency.
- A sCLK-EX DC power cable
- RF cable and Clock connect PCB : The standard sCLK-EX supplies a RF cable and a Clock connect PCB, and will be added extra according to the option.
- A U.FL – BNC cable : Supplied when ordering 50Ω Master Clock Option.
- A MCX – BNC cable : Supplied when ordering 75Ω Master Clock Option.
- A SATA power PCB
- A 3.5" bay bracket
- A operating instruction



Ultimate High Performance Audio

Specification

- **Internal reference clock**
Custom designed ultra low phase noise oscillation circuit
Isolated differential clock signal distribution
- **Clock output**
Isolated clock output : U.FL connector x 4
Supply matching board for connecting target board
- **Single clock frequency for interface system**
sCLK-EX12 : 12MHz
sCLK-EX25 : 25MHz
sCLK-EX48 : 48MHz
sCLK-EX22/24 : 22.5792MHz / 24.576MHz selectable by SEL0 input
sCLK-EX45/29 : 45.1584MHz / 49.152MHz selectable by SEL0 input
Optional other frequency available
- **Dual independent clock frequency for digital audio system**
SCLK-EX1412 : 14.318MHz, 12MHz
SCLK-EX1448 : 14.318MHz, 48MHz
SCLK-EX1425 : 14.318MHz, 25MHz
Optional other frequency available or selectable by SEL0, 1 input
- **Triple independent clock frequency for mother board & interface**
sCLK-EX142512 : 14.318MHz, 25MHz, 12MHz
sCLK-EX142548 : 14.318MHz, 25MHz, 48MHz
Optional other frequency available or selectable by SEL0, 1 input
- **Quad independent clock frequency for mother board & interface**
sCLK-EX14252612 : 14.318MHz, 25MHz, 26MHz, 12MHz
sCLK-EX14252648 : 14.318MHz, 25MHz, 26MHz, 48MHz
Optional other frequency available or selectable by SEL0, 1 input
- **Clock control input**
Isolated control input connector x 2
Non isolated control input x 7
Optional USB control available
- **External master clock input** : Optional
Input frequency : 10MHz (Optional other frequency available)
Isolated 50Ω external clock input : U.FL connector x 1
Isolated 75Ω external clock input : MCX connector x 1
Differential clock signal input & internal distribution
- **Power input**
Input Voltage : 9Vdc ~ 12Vdc (optional 6.5Vdc ~ 8.5Vdc)
Operating current : 1A >
- **Power output**
All output use ultra low noise regulator circuit
5V, 0.5A x 1
3.3V, 0.5A x 1
- **Power regulator circuit**
Custom designed ultra low noise regulator circuit x 3
Standard ultra low noise regulator circuit x 1
Active noise canceller circuit
- **Components**
Audio grade film capacitors
Audio grade tantalum capacitors
- **Operating environment**
Operating temperature range : +10 ~ +30°C
Storage temperature : 0 ~ +40°C
Operating & storage humidity : 10% ~ 90%

Product outlines

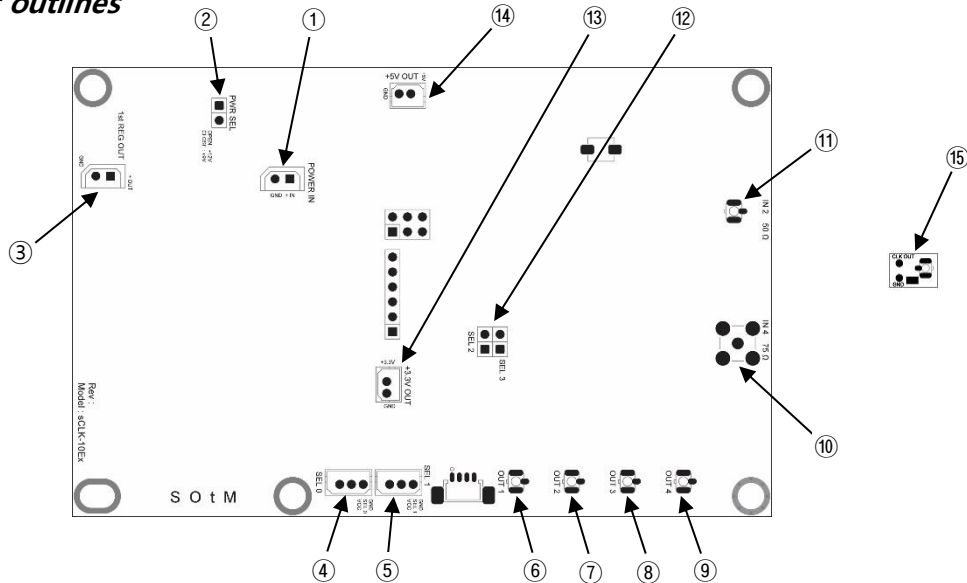

- ① Power input connector : Connect to +12Vdc or +9Vdc by the supplied DC power cable.
- ② Power voltage select jumper : Jumper Off when connecting +12Vdc. Jumper On when connecting +9Vdc.
- ③ Constant voltage output connector : Use when the other internal board needs powers. Output to about 8.6V when connecting +12Vdc, output to around 7.1V when connecting +9Vdc.
- ④ Frequency control input connector (SEL0) : Use when the frequency control input is needed.
- ⑤ Frequency control input connector (SEL1) : Use when the frequency control input is needed.
- ⑥ Clock output 1 (U.FL)
- ⑦ Clock output 2 (U.FL)
- ⑧ Clock output 3 (U.FL)
- ⑨ Clock output 4 (U.FL).
- ⑩ Master clock input connector (MCX) : 75 Ω connector for a master clock input
- ⑪ Master clock input connector (U.FL) : 50 Ω connector for a master clock input.
- ⑫ Frequency control select jumper (SEL2, 3) : To use, special order is required.
- ⑬ +3.3Vdc output connector: It is the output connector of the internal Ultra Low Noise Regulator. Use when needs +3.3Vdc from the other internal board.
- ⑭ +5Vdc output connector: It is the output connector of the internal Ultra Low Noise Regulator. Use when needs +5Vdc from the other internal board.
- ⑮ Clock connect PCB : Install to the other boards which needed to replace the clock and connect by the supplied RF cable.

sCLK-EX ordering information

sCLK-EX XX XX XX XX M50 75

① ② ③ ④ ⑤ ⑥

- ① A frequency for Clock output 1 (U.FL)
- ② A frequency for Clock output 2 (U.FL)
- ③ A frequency for Clock output 3 (U.FL)
- ④ A frequency for Clock output 4 (U.FL)
- ⑤ When adding 50Ω Master clock
- ⑥ When adding 75Ω Master clock

44.1K : 44.1KHz	48K : 48KHz
5.0 : 5MHz	10 : 10MHz
11 : 11.2896MHz	12 : 12.0MHz
12.2 : 12.288MHz	14 : 14.318MHz
22 : 22.5792MHz	24 : 24.576MHz
25 : 25.0MHz	26 : 26.0MHz
45 : 45.1584MHz	48 : 48MHz
49 : 49.152MHz	blank : no frequency output
xx/xx : selectable by SEL0 or SEL1 input	

Precautions

- On the back side of the sCLK-EX, each clock output frequency is labeling by the sticker. When connecting RF cable to other boards, be careful not to misconnect the frequency.
- The sticker on the back side of the sCLK-EX shouldn't be torn or damaged because the serial number is essentially needed if you want to add the master clock options, change the current frequency to the other frequency or enable the additional clock output to your current sCLK-EX.

sCLK-EX48 + tX-USBexp installation guide

www.sotm-audio.com

1. Remove the crystal oscillator(Y301) and R328 on tX-USBexp by soldering.
2. Install the supplied clock connect PCB () to the position of the removed Y301 by soldering.

Caution : The above no.1 and 2 processes are required to solder very carefully, otherwise the product would be damaged. If you are not proficient in soldering or doing these processes, please ask SOTM or the seller to do it. If you purchase the sCLK-EX48 + tX-USBexp combo package, please skip the above no.1 and 2 processes.

3. Power off the PC and disconnect the AC power cable.
4. Install the sCLK-EX48 using the supplied 3.5"bay bracket to the inside of PC case.
5. Connect the PC's SATA power cable to the supplied SATA power PCB. And connect it to the sCLK-EX48 by the supplied sCLK-EX DC power cable..
6. By the supplied RF cable, connect the soldered clock connect PCB() on the tX-USBexp to the Clock output 1 on the sCLK-EX48.
Caution : If you purchase the sCLK-EX48 + tX-USBexp combo package, connect the RF connector(J301) on the back side of tX-USBexp to the Clock output 1 on the sCLK-EX48 by the supplied RF cable.
7. Refer to the tX-USBexp installation guide(manual) and install the tX-USBexp into the PC.
8. Install the tX-USBexp driver and use.

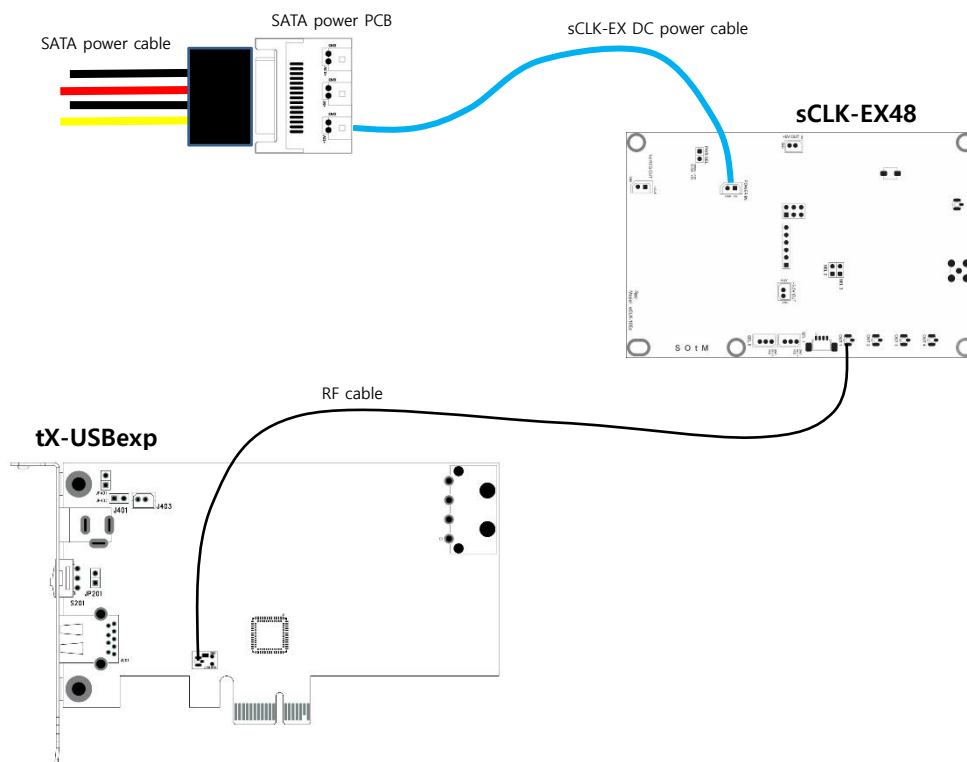

Precautions

- I. If there is any damage occurred while soldering the board by yourself, you are responsible for the damage or malfunction. If you are not proficient in soldering or doing the process, please ask SOTM or the seller.
- II. sCLK-EX48 is capable to synchronize an external clock as like 10MHz Master clock if you order the Master clock option.
- III. The sticker on the back side of the sCLK-EX shouldn't be torn or damaged because the serial number is essentially needed if you want to add the master clock options, change the current frequency to the other frequency or enable the additional clock output to your current sCLK-EX.

sCLK-EX12 + tX-USBhubIN installation guide

www.sotm-audio.com

1. Put 0Ω on R331 and R329. Put 249Ω on R328 and remove R327 on the tX-USBhubIN by soldering.(The resistor is 1608 size.)

Caution : The above no.1 process is required to solder very carefully, otherwise the product would be damaged. If you are not proficient in soldering or doing this process, please ask SOTM or the seller to do it.

If you purchase the sCLK-EX12 + tX-USBhubIN combo package, please skip this process..

2. Power off the PC and disconnect the AC power cable.
3. Install the sCLK-EX12 using the supplied 3.5"bay bracket to the inside of PC case.
4. Connect the PC's SATA power cable to the supplied SATA power PCB. And connect it to the sCLK-EX12 by the supplied sCLK-EX DC power cable.
5. By the supplied RF cable, connect the RF connector on tX-USBhubIN to the Clock output 1 on the sCLK-EX12.
6. Refer to the tX-USBhubIN instillation guide(manual) and install the tX-USBhubIN into the PC..

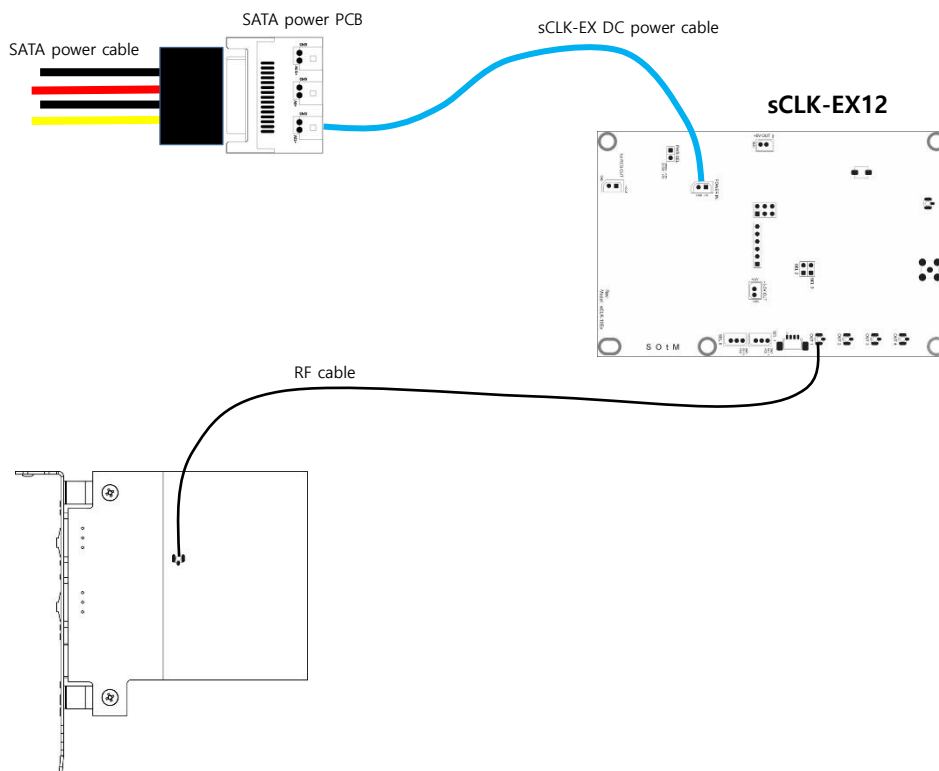

Precautions

- I. If there is any damage occurred while soldering the board by yourself, you are responsible for the damage or malfunction. If you are not proficient in soldering or doing the process, please ask SOTM or the seller.
- II. sCLK-EX12 is capable to synchronize an external clock like 10MHz Master clock if you order the Master clock option.
- III. The sticker on the back side of the sCLK-EX shouldn't be torn or damaged because the serial number is essentially needed if you want to add the master clock options, change the current frequency to the other frequency or enable the additional clock output to your current sCLK-EX.

1. Remove the crystal oscillator(Y301) and R328 on tX-USBexp by soldering.
2. Install the supplied clock connect PCB () to the position of the removed Y301 by soldering.

Caution : The above no.1 and 2 processes are required to solder very carefully, otherwise the product would be damaged. If you are not proficient in soldering or doing these processes, please ask SOTM or the seller to do it.



3. Power off the PC and disconnect the AC power cable.
4. Open the PC case and take out(disassemble) the main board.
5. Remove the system cristal (oscillator) on the main board and install the supplied clock connect PCB () to the position of the removed system cristal (oscillator) by soldering.

Caution : Normally the system cristal (oscillator) on the main board is 14.318MHz, but the correct frequency, type of components, required voltage and other information should be double confirmed by the technical data and the frequency measurement data before you proceed the installation.



6. Remove the Ethernet communications cristal oscillator on the main board and install the supplied clock connect PCB () to the position of the removed Ethernet communications cristal oscillator by soldering..

Caution : Normally the Ethernet communications cristal oscillator on the main board is 25MHz, but the correct frequency, type of components, required voltage and other information should be double confirmed by the technical data and the frequency measurement data, etc before you proceed the installation.

Cautions : If you purchase the sCLK-EX142548 + tX-USBexp + PC main board combo package, please skip the above no.1,2,5,6 processes.

7. Install the sCLK-EX142548 using the supplied 3.5"bay bracket to the inside of PC case.
8. Connect the PC's SATA power cable to the supplied SATA power PCB. And connect it to the sCLK-EX142548 by the supplied sCLK-EX DC power cable.
9. By the supplied RF cable, connect
the clock connect PCB() soldered where the system cristal (oscillator) on the main board to the Clock output 1,
the clock connect PCB() soldered where the Ethernet communications cristal (oscillator) on the main board to the Clock output 2,
the clock connect PCB() soldered where the cristal (oscillator) on the tX-USBexp to the Clock output 3 on the sCLK-EX142548.
Caution : If you purchase the sCLK-EX48 + tX-USBexp combo package, connect the RF connector(J301) on the back side of tX-USBexp to the Clock output 1 on the sCLK-EX48 by the supplied RF cable
10. Install the main board back to the PC case.
11. Refer to the tX-USBexp instllation guide(manual) and install the tX-USBexp into the PC.
12. Connect AC power cable to PC and Power on.
13. Install the tX-USBexp driver and use.

Precautions

- I. The installation guide is based on sCLK-EX142548 + tX-USBexp + PC main board combo package.
- II. Advanced technical skill should be required to confirm the correct frequency, type of component, required voltage and the specification for the clock upgrade. If you are not proficient in such information or soldering, please ask SOTM or the seller to do it. Otherwise, we highly recommend using the sCLK-EX combo packages.
- III. To confirm the required voltage for the clock upgrade, you will need to check the technical data of the clock input IC. Normally the required voltage for the clock signal is 3.3V and the supplied clock connect PCB () is  ned to output 3.3V too. But if the required voltage for the clock input is not 3.3V, you will need to ask SOTM to provide the other voltage of the clock connect PCB in advance the order.
- IV. The above no.5 and 6 processes are required soldering skills, otherwise the product would be damaged. If you are not proficient in soldering or doing these processes, please ask SOTM or the seller to do it. Otherwise, we recommend using the sCLK-EX combo package including the main board.
- V. Users who conduct the installation is responsible for any damage or malfunction. If there is any damage occurred while sodering the board by yourself, you are responsible for the damage or malfunction. If you are not proficient in soldering or doing the process, please ask SOTM or the seller.
- VI. sCLK-EX142548 is capable to synchronize an external clock as like 10MHz Master clock if you order the Master clock option.
- VII. The sticker on the back side of the sCLK-EX shouldn't be torn or damaged because the serial number is essentially needed if you want to add the master clock options, change the current frequency to the other frequency or enable the additional clock output to your current sCLK-EX.

VIII. If you commission SOTM or the seller do the upgrade on your main board, the labor cost and a round trip shipping cost should be required. If any damage is occurred for the requested main board while processing the upgrade, the repair cost would be charged to SOTM, the seller and the client who requested this upgrade equally, and the repair cost is calculated depreciation on the requested main board.

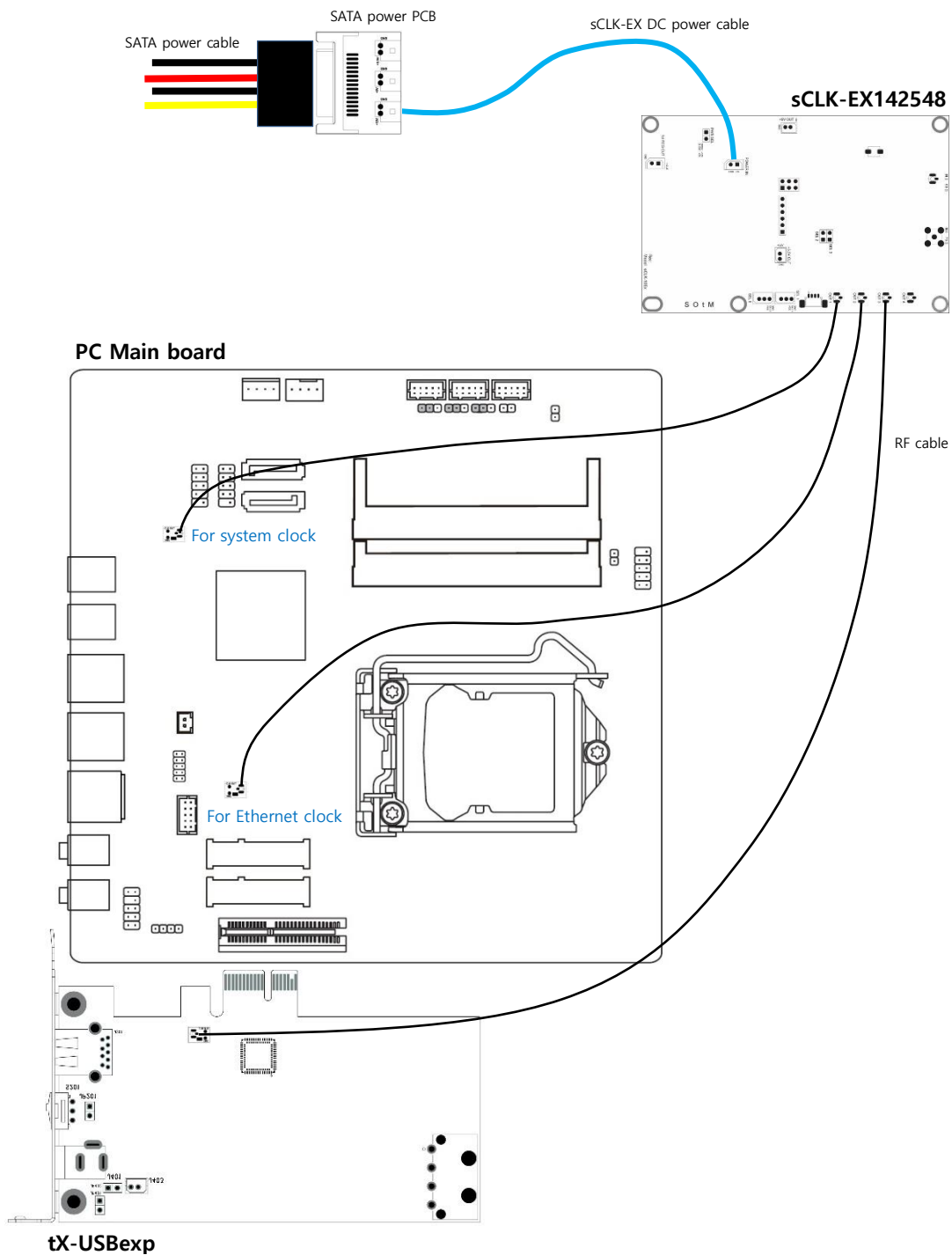

sCLK-EX master clock installation guide

www.sotm-audio.com

1. Refer to the sCLK-EX installation guide and install the sCLK-EX accordingly. Depends on what sCLK-EX package use, the different installation guide is provided.
2. A U.FL – BNC cable is for 50Ω impedance, a MCX – BNC cable is for 75Ω impedance. Refer to the image below and connect the correct cable according to the correct impedance of the external master clock input to the sCLK-EX and fasten the BNC connector brace to the PC case.
3. The Detect LED turns on once the clock output synchronizes to the external master clock input. The Detect LED located next to the Operate LED and the Operate LED blinks once the sCLK-EX operates normally.

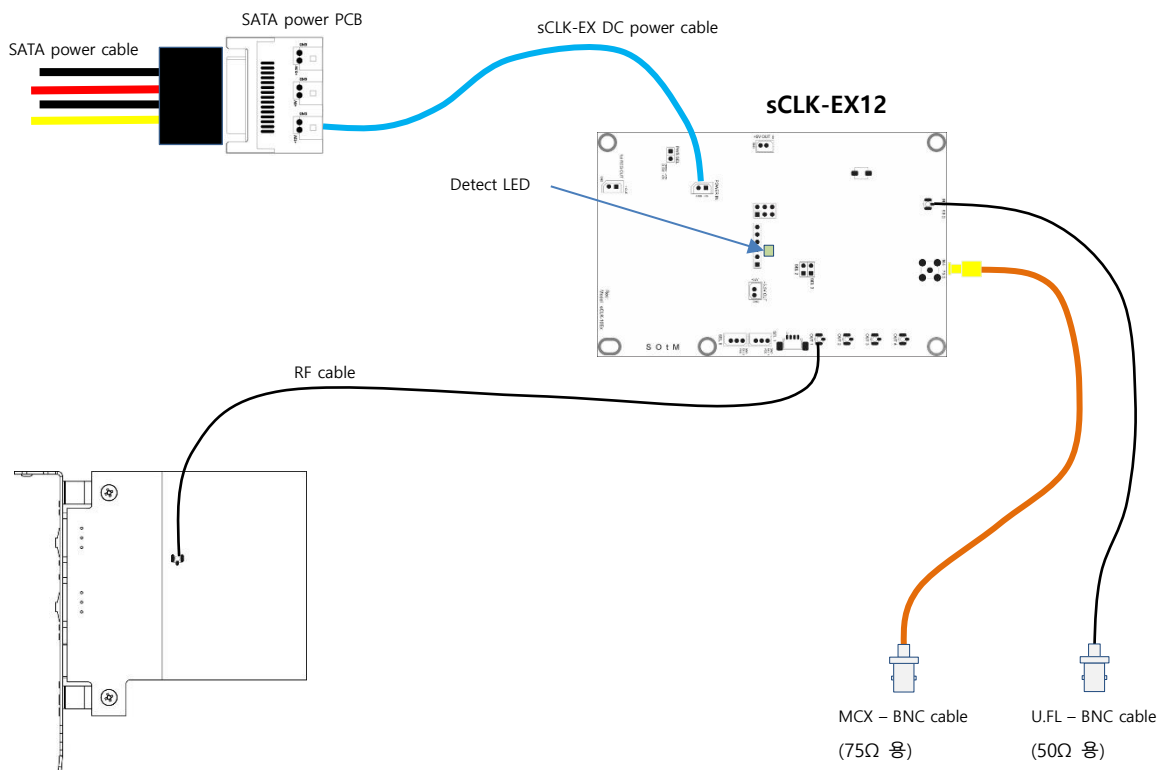

Precautions

- I. The installation guide is based on sCLK-EX12M5075 + tX-USBhubIN combo package. Please refer to how to name sCLK-EX, sCLK-EX12M5075 means enabled 12Mhz frequency for Clock output 1 and add 50Ω Master Clock Option and 75Ω Master Clock Option.
- I. The sCLK-EX master clock option offers
 - 50Ω Master Clock Option : it comes with 50Ω U.FL to BNC cable.
 - 75Ω Master Clock Option it comes with 75Ω MCX to BNC cable.
- II. The standard master clock input frequency is 10MHz. The different input frequency is available, if you need the different input frequency, you will need to ask in advance of the order.
- III. All sCLK-EX is capable to synchronize an external clock as like 10MHz Master clock if you order the Master clock option.
- IV. The sticker on the back side of the sCLK-EX shouldn't be torn or damaged because the serial number is essentially needed if you want to add the master clock options, change the current frequency to the other frequency or enable the additional clock output to your current sCLK-EX.